

SEEPEX.
An Ingersoll Rand Business

TO THE EXACT DROP PRODUCT GROUP D



FOR HIGHEST PRECISION.

SEEPEx metering pumps have highly repeatable accuracy. They're used to handle thin to highly viscous products that can be entrained with or without solids and are corrosive, all with minimal pulsation and to the exact drop.

ROTOR

Wear resistant and corrosion resistant materials.

COUPLING ROD

Two pin joints with hardened and wear resistant components, easily assembled, grease lubricated and positively sealed with elastomer sleeves and two holding bands.

STATOR ADAPTER

In stainless steel, enabling interchangeability of all sizes of rotor/stator giving infinite turn down with only one housing and drive unit.

PRESSURE BRANCH

Available in stainless steel or plastic, 1/2" connections to DIN EN ISO 228-1 or NPT.

TIE RODS AND SCREW CONNECTIONS

In stainless steel.

STATOR

The seal on both ends is molded as an integral part of the elastomeric stator; corrosion of the stator tube is prevented as the pumped liquid does not come in contact with the metal tube or the bonding adhesive.

LANTERN

For connecting the pump and drive.

SUCTION CASING

Available in stainless steel or plastic, 1" connection to DIN EN ISO 228-1 or NPT, can be rotated in 90° increments, with drain plug/gauge connections.

DRIVE

Geared motors, variable speed drives or hydraulic motors of all major manufacturers can be directly flanged to the pump without additional couplings or guards. Smart programmable vector drives available. Program parameters are factory loaded onto a memory chip, which makes duplication fast and easy. A 4-20 mA process signal can be connected via a terminal strip inside the control box.

PLUG-IN SHAFT CONNECTION

Enables easy dismantling of the pump and drive for quick replacement of the rotating parts and shaft seal. The plug-in shaft pin secures the shaft connection to the drive and the splash ring protects the bearing from contamination/gland leakage.

PLUG-IN SHAFT

Connects the drive shaft to the universal joint.

SHAFT SEAL

Single acting mechanical seal. Optional: double acting mechanical seal, gland packing or lip seal.

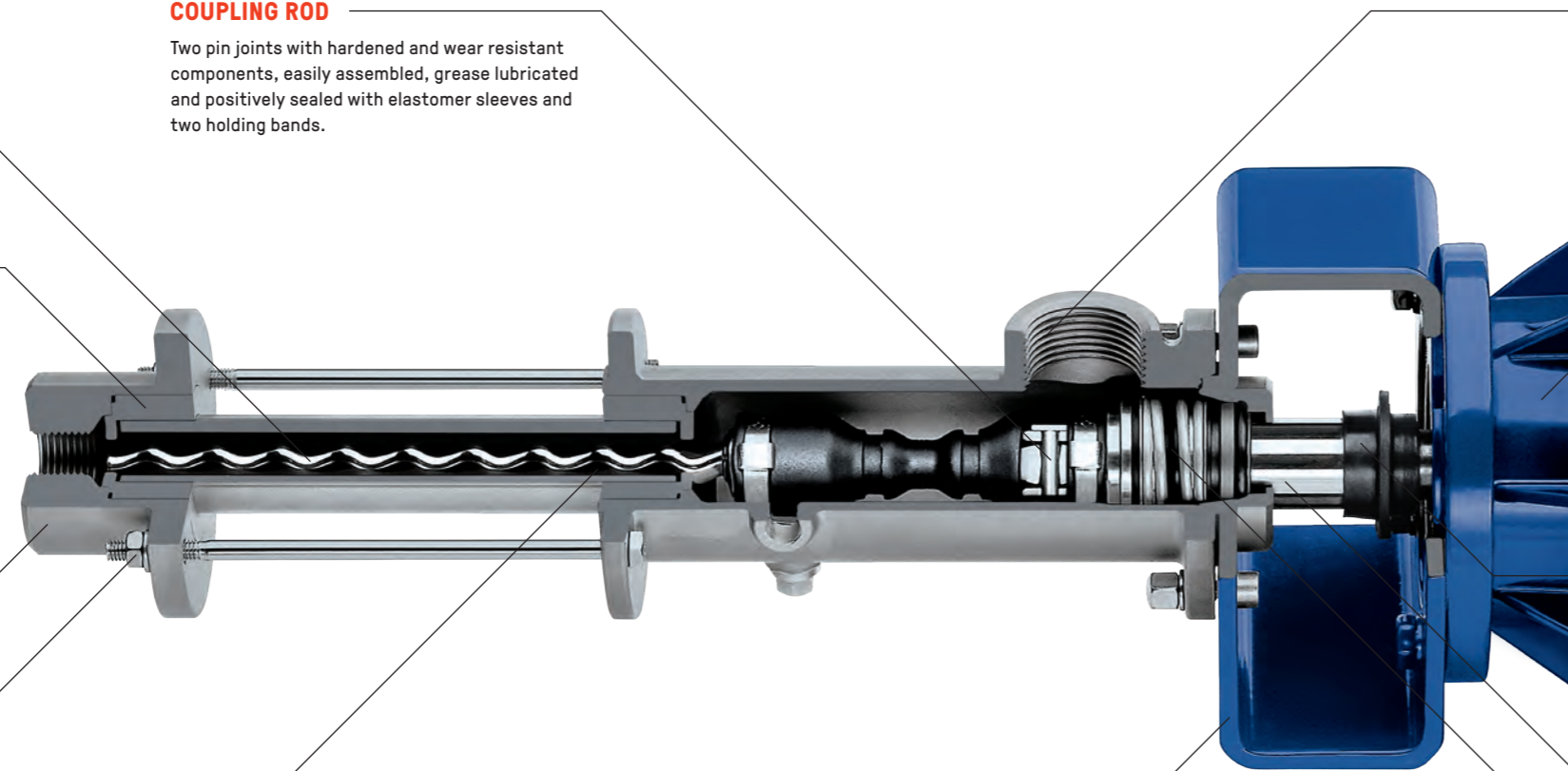

OVERVIEW OF RANGES

MD RANGE

The modular design of the MD range incorporates six sizes of metering pumps which are available with stainless steel or plastic casings. Rotating components are also manufactured from Hastelloy or Titanium. These pumps are the ideal choice for minimal pulsation metering of low to highly viscous fluids with or without entrained solids and are chemically aggressive.

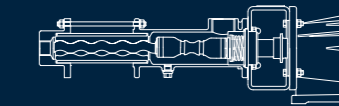

MDP RANGE

The MDP range pumps are available with stainless steel or plastic housings. A special feature is the one-piece, wear resistant plastic rotating unit without joint.

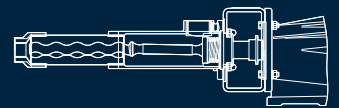

MDT RANGE

The MDT range pumps feature a rectangular open hopper with a compression zone and an auger feed screw. The length of the hopper opening is variable to suit the installation requirements. They are used for pumping highly viscous products with or without entrained solids. The MDT range is equipped with the proven closed pin joint.

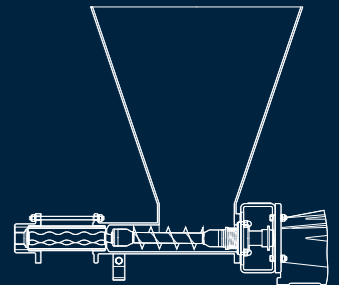

MDC RANGE

The MDC range of pumps are equipped with open barrel-shaped pin joints that can be cleaned effectively through CIP cleaning. They meet the highest demands of cleanliness, safety and corrosion or wear resistance. Service work can be performed easily and rapidly without the need for special tools. They are built with FDA compliant components, certified acc. to the 3-A Sanitary Standards (USA) and designed in compliance with the EHEDG directives.

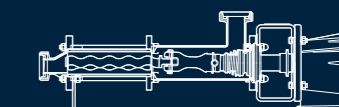

MDTC RANGE

The MDTC range features a rectangular open hopper with a compression zone and an auger feed screw which assists the product into the pumping elements, the rotor and stator. The length of the hopper opening is variable to suit the application conditions. They are used for pumping highly viscous products with or without entrained solids. The MDTC range pumps are equipped with open barrel-shaped pin joints that can be cleaned effectively through CIP cleaning. They meet the highest demands of cleanliness, safety and corrosion or wear resistance. Service work can be performed easily and rapidly without the need for special tools. They are built with FDA compliant components, certified acc. to the 3-A Sanitary Standards (USA) and designed in compliance with the EHEDG directives.

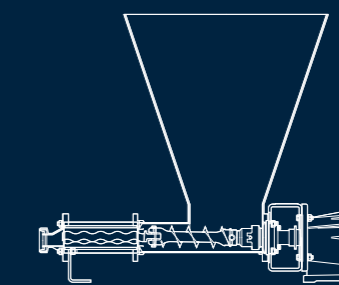

MDF RANGE

The MDF range pumps are used for emptying barrels with a 2" hole. The liquid level in the container provides a positive feed. These pumps are ideal for handling thin to highly viscous products and ensuring complete emptying. The pump can be easily transported by a handle attachment.

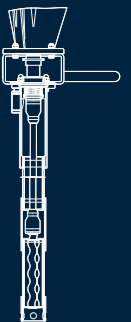

APPLICATIONS

The six ranges of metering pumps can be used in virtually all industries for metering and dosing precise quantities. They are particularly good for minimal pulsation conveying of thin to high viscosity fluids, as well as corrosive media containing solids.

They are used for applications in agriculture; automotive assembly; bakeries; building products; ceramics; chemical and biochemical processing; coating kitchens, stock preparation and deinking in paper mills; confectioneries; dairies; distilleries; dye and ink plants; fruit and vegetable processing; pharmaceuticals, cosmetics and personal care products; poultry, meat and fish processing; oil, gas and petrochemicals; ship building; sewage sludge dewatering; wastewater treatment; water purification; wineries and wood treatment and fabrication.

FEATURES

- Simple interchangeability due to their modular construction
- Infinite turn down
- Minimal pulsation, no pulsation dampers required
- Constant flow, independent of pressure
- Low shear characteristics
- High metering accuracy
- Valveless flow control
- No check valves, no gas locking or blocking by solids
- Drive options and control systems available that allow user-friendly metering applications

KEY FACTS

- Conveying capacity:
0.06 l/h–1,000 l/h (0.016–264 USGPH)
- Pressure:
up to 24 bar (350 psi)

SEEPEX GmbH

www.seepe.com